

Mid-Power LED - 2835 Series

STW8A12D-S1(IAH0)



Product Brief

Description

- This White Colored surface-mount LED comes in standard package dimension. Package Size: 3.5x2.8x0.7mm
- It has a substrate made up of a molded plastic reflector sitting on top of a lead frame.
- The die is attached within the reflector cavity and the cavity is encapsulated by silicone.
- The package design coupled with careful selection of component materials allow these products to perform with high reliability.

Features and Benefits

- Market Standard 3528 Package Size
- High Color Quality, CRI Min. 80
- RoHS compliant

Key Applications

- Interior lighting
- General lighting
- Indoor and outdoor displays
- Architectural / Decorative lighting

Table 1. Product Selection Table

Part Number	CCT			
	Color	Min.	Typ.	Max.
STW8A12D-S1(IAH0)	Cool White	4650K	5600K	7000K
STW8A12D-S1(IAH0)	Neutral White	3700K	4000K	4200K
STW8A12D-S1(IAH0)	Warm White	2580K	3000K	3700K

Table of Contents

Index

• Product Brief	1
• Table of Contents	2
• Performance Characteristics	3
• Characteristics Graph	5
• Color Bin Structure	8
• Mechanical Dimensions	10
• Emitter Tape & Reel Packaging	12
• Product Nomenclature	13
• Precaution For Use	14
• Company Information	17

Performance Characteristics

Table 2. Product Selection Guide, $I_F = 60\text{mA}$, $T_j = 25^\circ\text{C}$, RH30%

Part Number	CCT (K) ^[1]	RANK	Luminous Flux ^[3]		CRI
	Typ.		Φ_V (lm)		R_a
			Min	Max	Min.
STW8A12D-S1 (IAH0)	6500	L28	28	30	80
	6300	L28	28	30	80
	6000	L28	28	30	80
	5700	L28	28	30	80
	5000	L28	28	30	80
	4000	L28	28	30	80
	3500	L26	26	28	80
		L28	28	30	80
	3000	L26	26	28	80
		L28	28	30	80
2700	L26	26	28	80	

Notes :

- (1) Correlated Color Temperature is derived from the CIE 1931 Chromaticity diagram.
- (2) Seoul Semiconductor maintains a tolerance of $\pm 7\%$ on Flux and power measurements.
The luminous Flux was measured at the peak of the spatial pattern which may not be aligned with the mechanical axis of the LED package.

Performance Characteristics

Table 3. Characteristics, $I_F=60\text{mA}$, $T_J= 25^\circ\text{C}$, RH30%

Parameter	Symbol	Value			Unit
		Min.	Typ.	Max.	
Forward Current	I_F	-	60	-	mA
Forward Voltage	V_F	2.8	3.0	3.2	V
Luminous Flux ^[1] (6,500K) ^[2]	I_v	28	29	-	lm
CRI ^[3]	R_a	80	83	90	
Viewing Angle	$2\theta_{1/2}$	-	120	-	Deg.
Storage Temperature	T_{stg}	- 40	-	+ 85	$^\circ\text{C}$
Thermal resistance (J to S) ^[4]	$R\theta_{J-S}$	-	60	-	$^\circ\text{C}/\text{W}$
ESD Sensitivity(HBM)	-	Class 2 JESD22-A114-E			

Table 4. Absolute Maximum Ratings

Parameter	Symbol	Value	Unit
Forward Current	I_F	150	mA
Power Dissipation	P_D	0.48	W
Junction Temperature	T_j	115	$^\circ\text{C}$
Operating Temperature	T_{opr}	-40 ~ + 85	$^\circ\text{C}$
Storage Temperature	T_{stg}	-40 ~ + 100	$^\circ\text{C}$
Pulse Forward Current	I_{FP}	150	mA
Reverse Voltage	V_r	5	V

Notes :

- (1) Seoul Semiconductor maintains a tolerance of $\pm 10\%$ on Flux and power measurements.
- (2) Correlated Color Temperature is derived from the CIE 1931 Chromaticity diagram.
Color coordinate : ± 0.01 , CCT $\pm 5\%$ tolerance.
- (3) Tolerance is ± 3.0 on CRI , ± 0.3 on VF measurements.
- (4) Thermal resistance is junction to Solder.
- (5) I_{FP} conditions with pulse width $\leq 10\text{ms}$ and duty cycle $\leq 10\%$
- (6) The products are sensitive to static electricity and must be carefully taken when handling products

- **Calculated performance values are for reference only.**
- **All measurements were made under the standardized environment of Seoul Semiconductor.**

Characteristics Graph

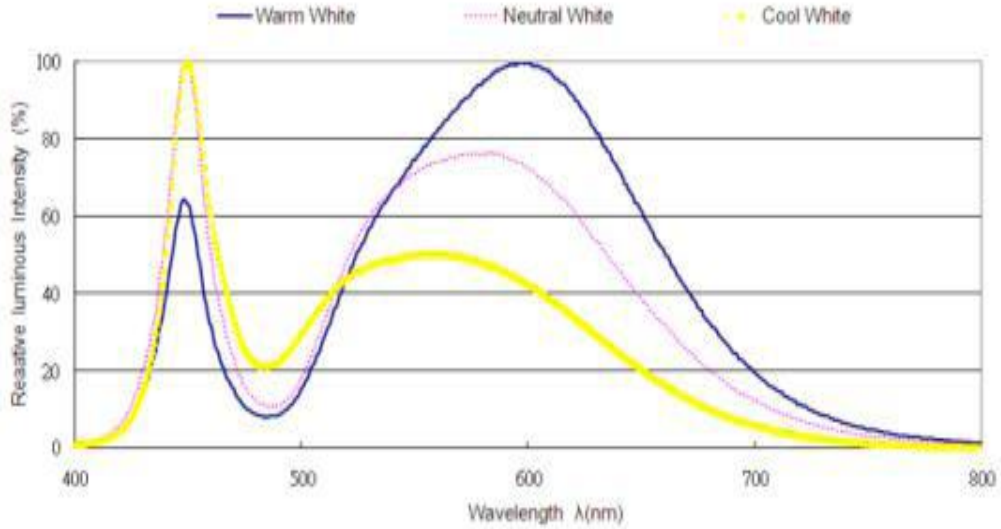
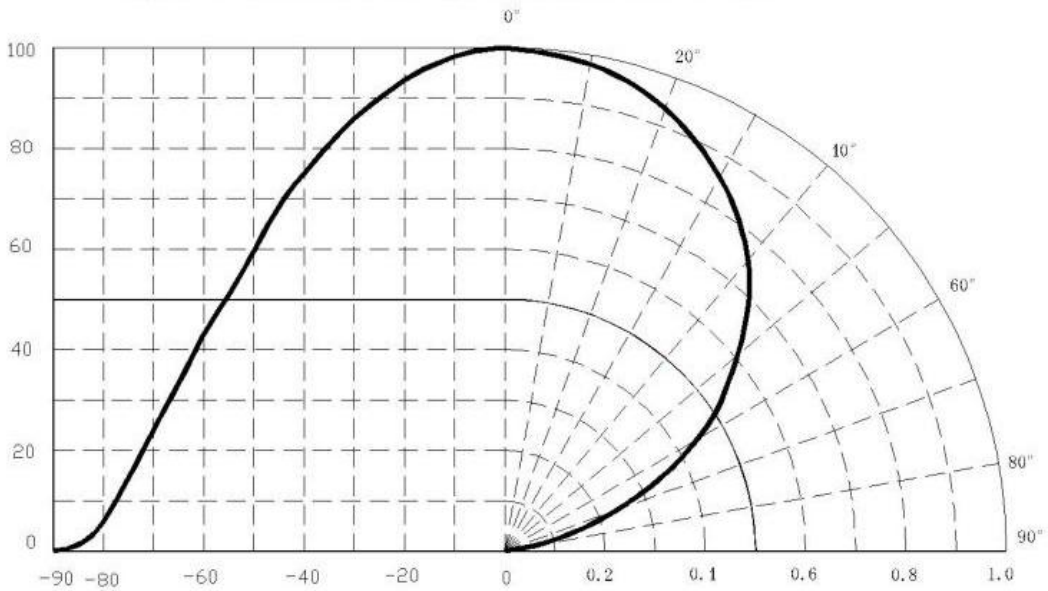
Fig 1. Color Spectrum, $T_j = 25^\circ\text{C}$, $I_F = 60\text{mA}$

Fig 2. Radiant Pattern, $T_j = 25^\circ\text{C}$, $I_F = 60\text{mA}$

Characteristics Graph

Fig 3. Forward Voltage vs. Forward Current, $T_j = 25^\circ\text{C}$

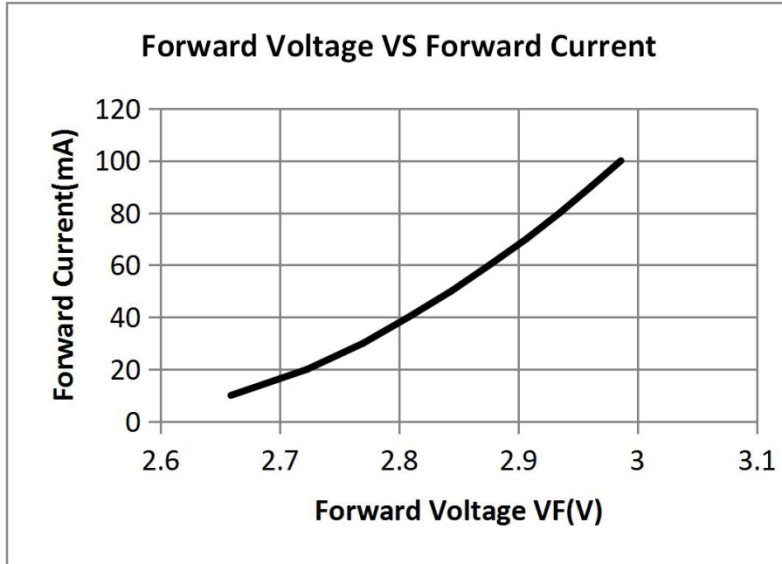
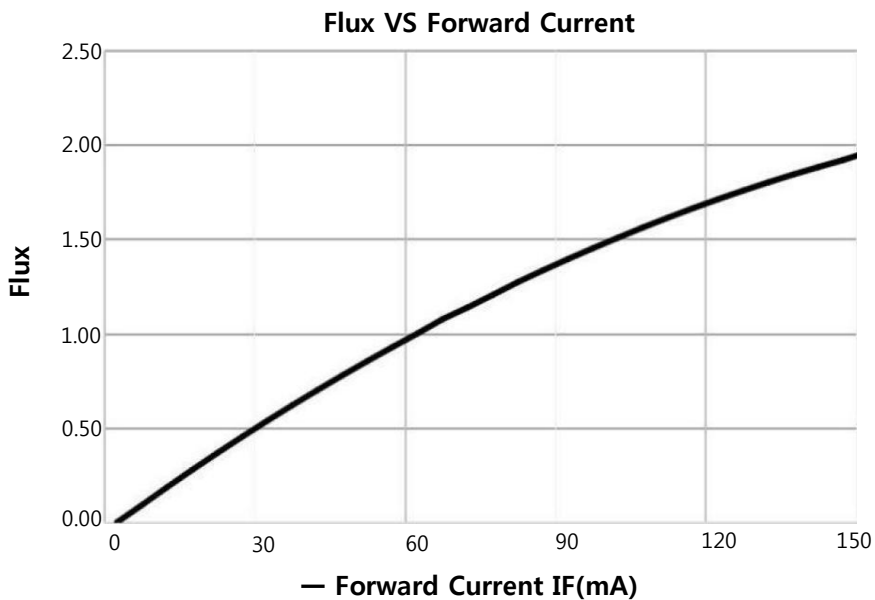

Fig 4. Forward Current vs. Relative Luminous Flux, $T_j = 25^\circ\text{C}$



Characteristics Graph

Fig 5. Solder Temp.v/s Forward current (Derating curve)

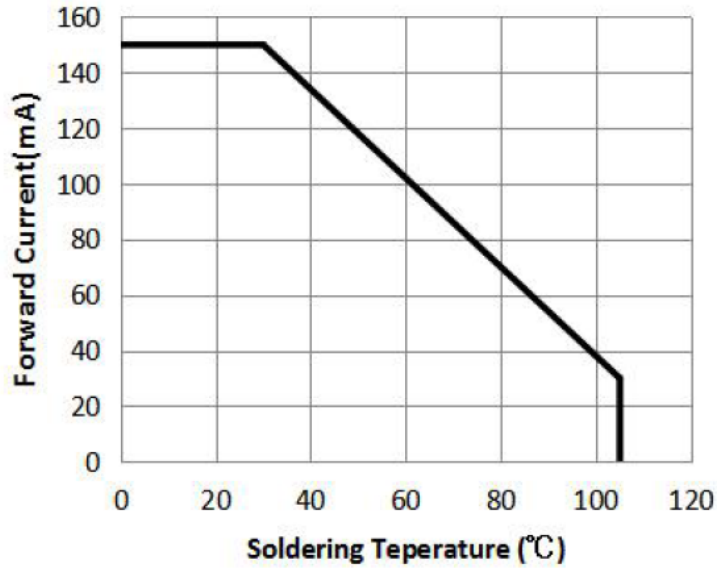
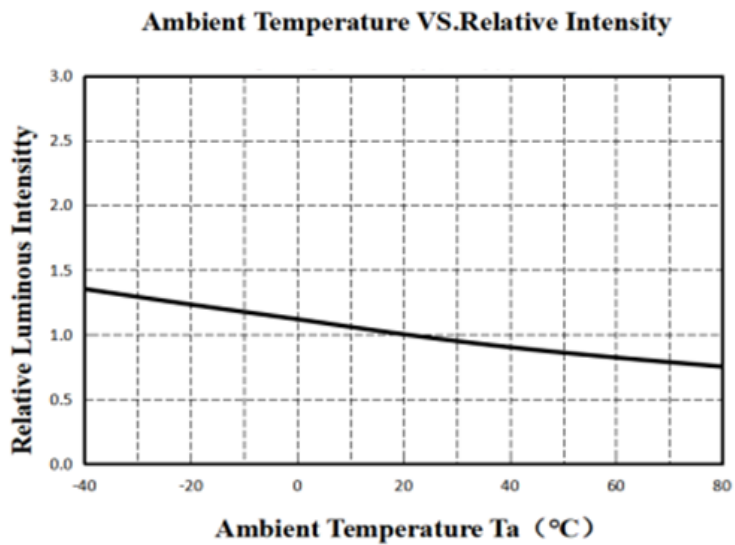
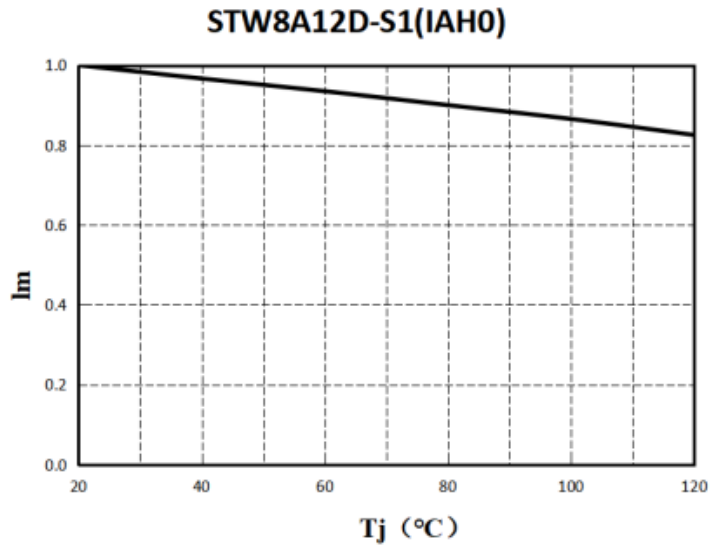

Fig 6. Temp.v/s Lumens current



Characteristics Graph

Fig 7. Junction Temperature vs. Relative Luminous Intensity, $I_F=60\text{mA}$



Color Bin Structure

Table 5. Bin Code description, $T_j=25^{\circ}\text{C}$, $I_F=60\text{mA}$

Part Number	Luminous Flux (lm)			Color Chromaticity Coordinate	Typical Forward Voltage (V)		
	Bin Code	Min.	Max.		Bin Code	Min.	Max.
STW8A12D-S1 (IAH0)	L26	26	28	Refer to Page. 8	H2	2.8	2.9
	L28	28	30		H3	2.9	3.0
					H4	3.0	3.1
					H5	3.1	3.2

***Notes :**

(1) Calculated performance values are for reference only.

- **All measurements were made under the standardized environment of Seoul Semiconductor. In order to ensure availability, single color rank will not be orderable.**

Color Bin Structure

CIE Chromaticity Diagram, $T_j=25^\circ\text{C}$, $I_f=60\text{mA}$

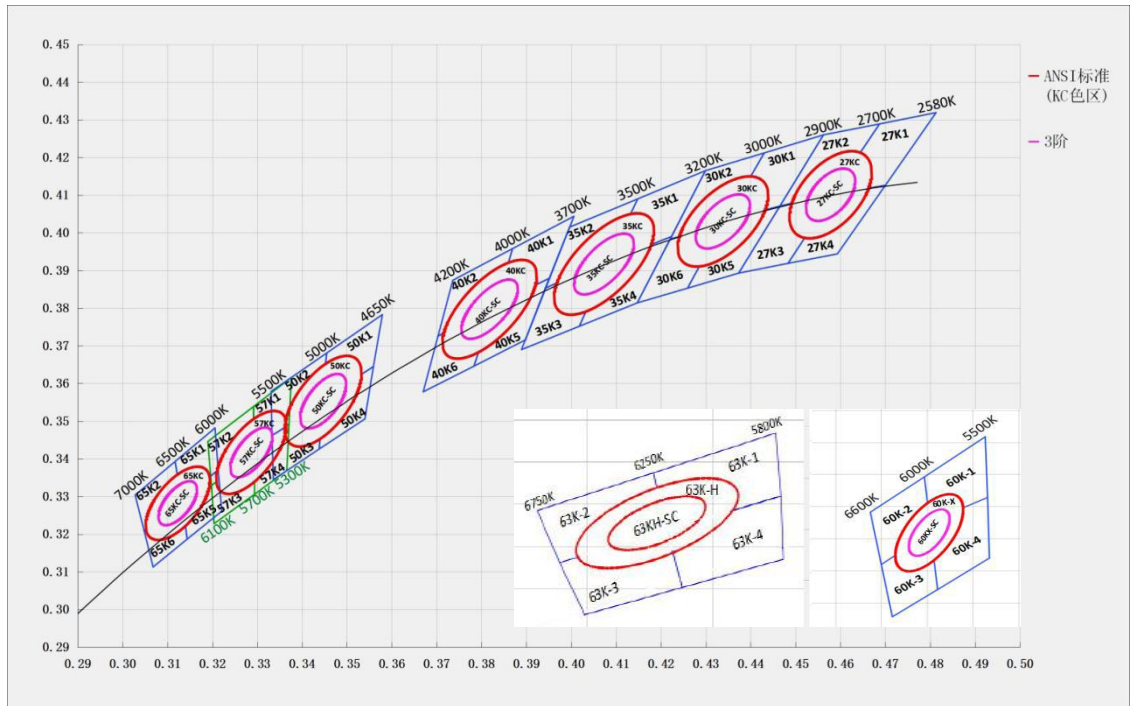

65KC-SC/ 65KC	X	0.3123	63KH-SC/ 63K-H	X	0.3156	60KX-SC/ 60K-X	X	0.3205
	Y	0.3282		Y	0.3405		Y	0.3418
	a	0.00223		a	0.0023		a	0.0026
	b	0.00095		b	0.00095		b	0.0011
	θ	58.38333		θ	65		θ	65
SDCM	3/5	SDCM	3/5	SDCM	3/5			
57KC-SC/ 57KC	X	0.3287	50KC-SC/ 50KC	X	0.3447	40KC-SC/ 40KC	X	0.3818
	Y	0.3417		Y	0.3553		Y	0.3797
	a	0.002486		a	0.00274		a	0.00313
	b	0.001066		b	0.00118		b	0.00134
	θ	59.09		θ	59.62		θ	54
SDCM	3/5	SDCM	3/5	SDCM	3/5			
35KC-SC/ 35KC	X	0.4073	30KC-SC/ 30KC	X	0.4338	27KC-SC/ 27KC	X	0.4578
	Y	0.3917		Y	0.403		Y	0.4101
	a	0.00317		a	0.00278		a	0.00258
	b	0.00139		b	0.00136		b	0.00137
	θ	52.96667		θ	53.16667		θ	57.28333
SDCM	3/5	SDCM	3/5	SDCM	3/5			

***Notes :**

- (1) Energy Star binning applied to all 2600~7000K.
- (2) Measurement Uncertainty of the Color Coordinates : ± 0.01

Color Bin Structure

CIE Chromaticity Diagram, $T_j=25^\circ\text{C}$, $I_f=60\text{mA}$

色区	X	Y	色区	X	Y	色区	X	Y	色区	X	Y
65K1	0.3206	0.3482	65K2	0.3117	0.3393	65K5	0.3221	0.3261	65K6	0.3131	0.329
	0.3117	0.3393		0.3028	0.3304		0.3144	0.3187		0.3048	0.3209
	0.3131	0.329		0.3048	0.3209		0.3131	0.329		0.3068	0.3113
	0.3213	0.3371		0.3131	0.329		0.3213	0.3371		0.3144	0.3187
色区	X	Y	色区	X	Y	色区	X	Y	色区	X	Y
63K-1	0.3164	0.3389	63K-2	0.3164	0.3389	63K-3	0.3164	0.3389	63K-4	0.3164	0.3389
	0.3255	0.3469		0.3153	0.3524		0.3078	0.3312		0.3176	0.3253
	0.3251	0.3618		0.306	0.3435		0.3098	0.3189		0.3257	0.332
	0.3153	0.3524		0.3078	0.3312		0.3176	0.3253		0.3255	0.3469
色区	X	Y	色区	X	Y	色区	X	Y	色区	X	Y
60K-1	0.3208	0.3417	60K-2	0.3208	0.3417	60K-3	0.3208	0.3417	60K-4	0.3208	0.3417
	0.3332	0.3528		0.3194	0.3592		0.31	0.3319		0.3223	0.3241
	0.3327	0.3717		0.3076	0.3482		0.3124	0.3156		0.3336	0.3339
	0.3194	0.3592		0.31	0.3319		0.3223	0.3241		0.3332	0.3528
色区	X	Y	色区	X	Y	色区	X	Y	色区	X	Y
57K1	0.3376	0.3616	57K2	0.319	0.3446	57K3	0.3204	0.3228	57K4	0.3293	0.3419
	0.3292	0.3539		0.3198	0.3329		0.3294	0.3306		0.3294	0.3306
	0.3293	0.3419		0.3293	0.3419		0.3293	0.3419		0.3366	0.3369
	0.3371	0.3493		0.3292	0.3539		0.3198	0.3329		0.3371	0.3493
色区	X	Y	色区	X	Y	色区	X	Y	色区	X	Y
50K1	0.3455	0.3681	50K2	0.3333	0.3462	50K3	0.3438	0.3426	50K4	0.3559	0.3645
	0.3579	0.3783		0.3331	0.3579		0.3336	0.3345		0.354	0.3506
	0.3559	0.3645		0.3455	0.3681		0.3333	0.3462		0.3438	0.3426
	0.3446	0.3553		0.3446	0.3553		0.3446	0.3553		0.3446	0.3553
色区	X	Y	色区	X	Y	色区	X	Y	色区	X	Y
40K1	0.3869	0.3958	40K2	0.3869	0.3958	40K5	0.3952	0.388	40K6	0.3828	0.3803
	0.4006	0.4044		0.3736	0.3874		0.3898	0.3716		0.3703	0.3726
	0.3952	0.388		0.3703	0.3726		0.3783	0.3646		0.367	0.3578
	0.3828	0.3803		0.3828	0.3803		0.3828	0.3803		0.3783	0.3646
色区	X	Y	色区	X	Y	色区	X	Y	色区	X	Y
35K1	0.4083	0.3921	35K2	0.3942	0.3853	35K3	0.3889	0.369	35K4	0.4018	0.3752
	0.4148	0.409		0.3996	0.4015		0.3942	0.3853		0.4083	0.3921
	0.4299	0.4156		0.4148	0.409		0.4083	0.3921		0.4223	0.399
	0.4223	0.399		0.4083	0.3921		0.4018	0.3752		0.4147	0.3814
色区	X	Y	色区	X	Y	色区	X	Y	色区	X	Y
30K1	0.4342	0.4027	30K2	0.4221	0.3984	30K5	0.4342	0.4027	30K6	0.4221	0.3984
	0.443	0.4212		0.4299	0.4165		0.4259	0.3853		0.4147	0.3814
	0.4562	0.426		0.443	0.4212		0.4373	0.3893		0.4259	0.3853
	0.4465	0.4071		0.4342	0.4027		0.4465	0.4071		0.4342	0.4027
色区	X	Y	色区	X	Y	色区	X	Y	色区	X	Y
27K1	0.4813	0.4319	27K2	0.4687	0.4289	27K3	0.4373	0.3893	27K4	0.47	0.4126
	0.4687	0.4289		0.4562	0.426		0.4465	0.4071		0.4582	0.4098
	0.4582	0.4098		0.4465	0.4071		0.4582	0.4098		0.4483	0.3919
	0.47	0.4126		0.4582	0.4098		0.4483	0.3919		0.4593	0.3944

Mechanical Dimensions : Unit (mm)

Type 1

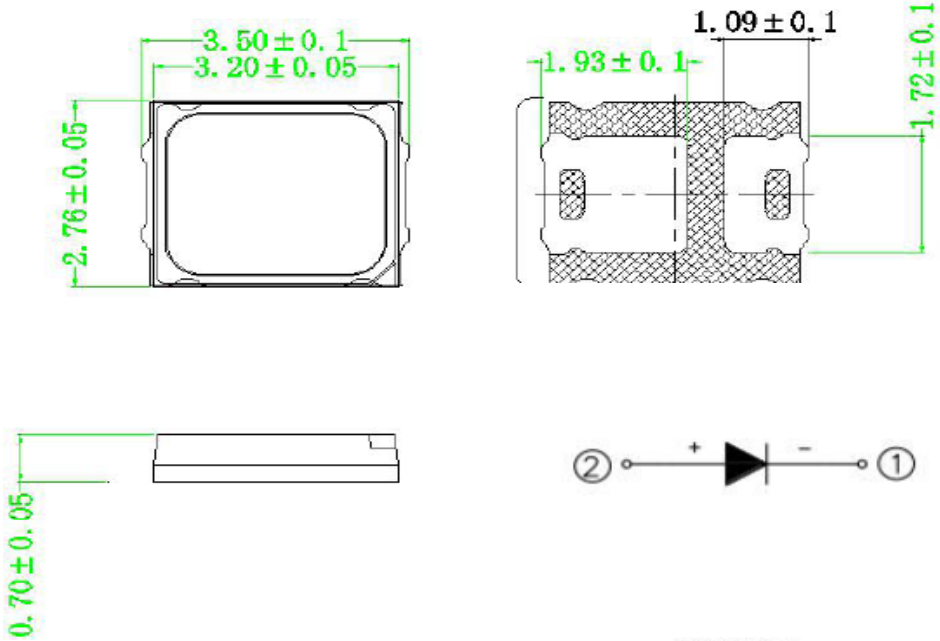

Polarity

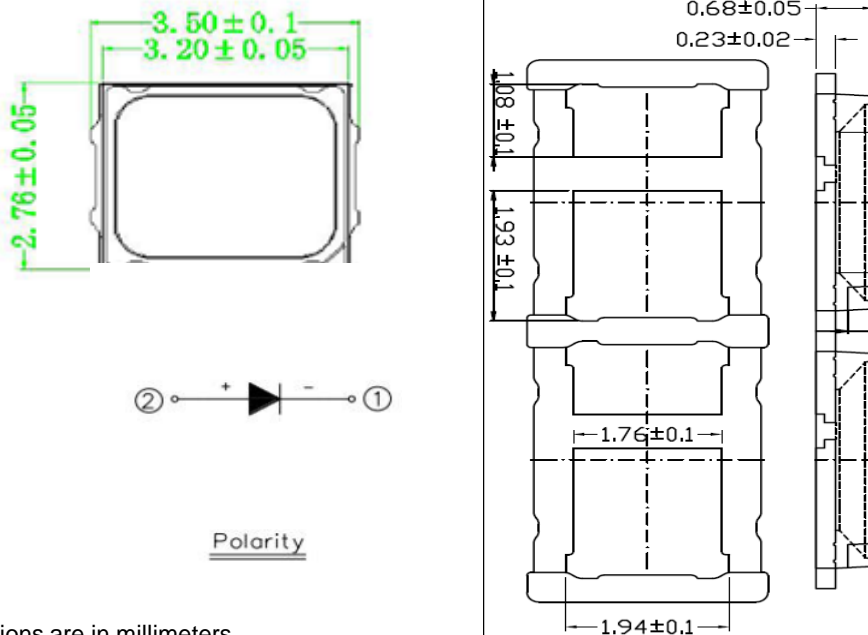
Type 2

Polarity
Notes :

- (1) All dimensions are in millimeters.
- (2) Scale : none
- (3) Undefined tolerance is $\pm 0.2\text{mm}$

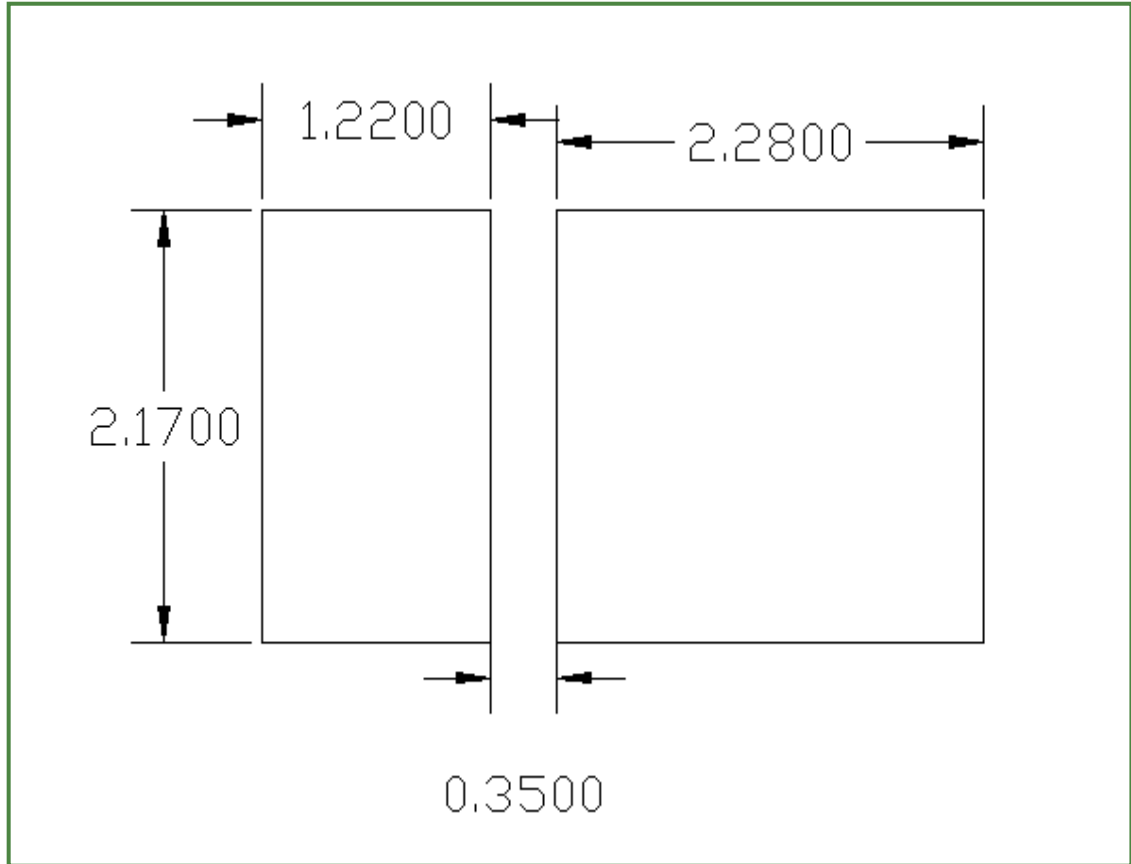
Recommended Solder Pad

Notes :

- (1) All dimensions are in millimeters.
- (2) Scale : none
- (3) This drawing without tolerances are for reference only
- (4) Undefined tolerance is $\pm 0.1\text{mm}$
- (5) The appearance and specifications of the product may be changed for improvement without notice.

Reliability Test Items and Condition

Test Item	Ref.Standard	Test Conditions	Time	Quantity(pcs)
High Temperature storage	JESD22-A103	Temp:100°C±5°C	1000 hrs	22
Low Temperature Storage	JESD22-A119	Temp:-40°C±5°C	1000 hrs	22
Temperature Cycle	JESD22-A104	100°C±5°C 30min ↓↑5min -40°C±5°C 30min	300 cycle	22
Reflow	JESD22-B106	Temp:max260°C Time:10sec 8min/cycle	3cycle	22
Life Test	JESD22-A108	Ta=25°C±5°C IF=100mA	1000 hrs	22
High Temperature High Humidity Life Test	JESD22-A101	85°C±5°C/85%RH I _F =100mA	1000 hrs	22

Notes :

Reflow Soldering Characteristics

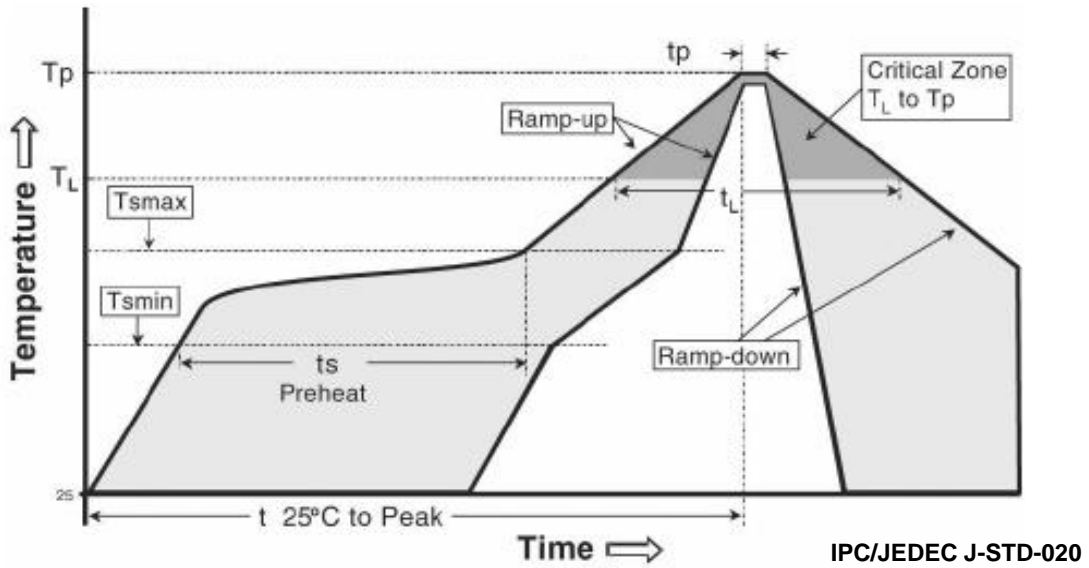

Profile Feature	Sn-Pb Eutectic Assembly	Pb-Free Assembly
Average ramp-up rate (T_{s_max} to T_p)	3° C/second max.	3° C/second max.
Preheat - Temperature Min (T_{s_min}) - Temperature Max (T_{s_max}) - Time (T_{s_min} to T_{s_max}) (t_s)	100 °C 150 °C 60-120 seconds	150 °C 200 °C 60-180 seconds
Time maintained above: - Temperature (T_L) - Time (t_L)	183 °C 60-150 seconds	217 °C 60-150 seconds
Peak Temperature (T_p)	215°C	260°C
Time within 5°C of actual Peak Temperature (t_p) ²	10-30 seconds	20-40 seconds
Ramp-down Rate	6 °C/second max.	6 °C/second max.
Time 25°C to Peak Temperature	6 minutes max.	8 minutes max.

Caution :

- (1) Reflow soldering is recommended not to be done more than two times
In the case of more than 24 hours passed soldering after first, LEDs will be damaged.
- (2) Repairs should not be done after the LEDs have been soldered
When repair is unavoidable, suitable tools must be used.
- (3) Die slug is to be soldered.
- (4) When soldering, do not put stress on the LEDs during heating.
- (5) After soldering, do not warp the circuit board.

Emitter Tape & Reel Packaging

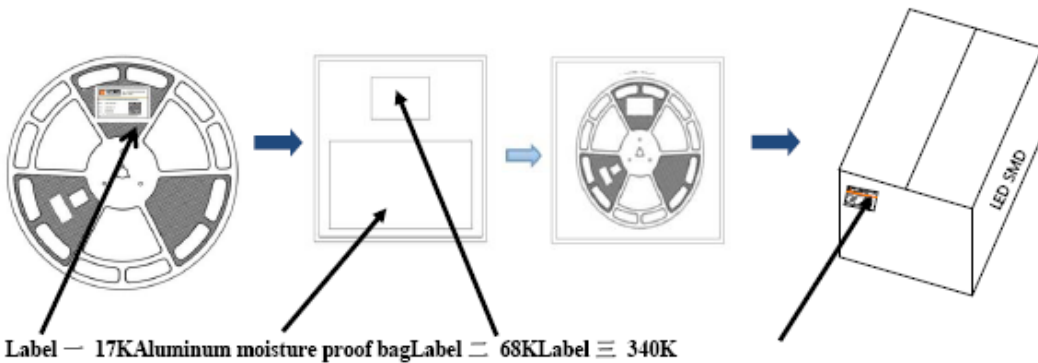
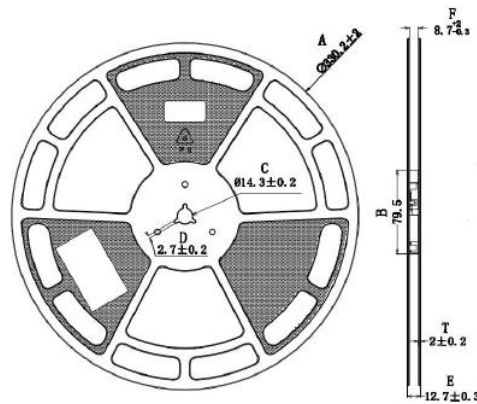
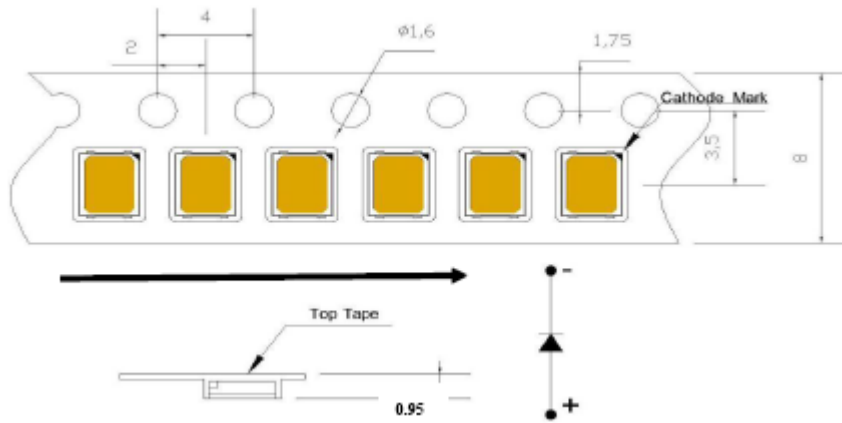

NOTES :

- Empty component pockets are sealed with top cover tape;
- The maximum number of missing lamps is two;
- The cathode is oriented towards the tape sprocket hole in accordance with ANSI/EIA RS-481 specifications.
- 17,000 pcs / Reel.

Product Nomenclature

Table 7. Part Numbering System : X₁X₂X₃X₄X₅X₆X₇X₈ - X₉X₁₀(X₁₁X₁₂X₁₃X₁₄)

Part Number Code	Description	Part Number	Value
X ₁	Company	S	
X ₂	Top View LED series	T	
X ₃ X ₄	Color Specification	W8	CRI 80
X ₅	Package series	A	A series
X ₆ X ₇	Characteristic code	12	
X ₈	Version	D	
X ₉ X ₁₀	Internal code	S1	
X ₁₁ X ₁₂ X ₁₃ X ₁₄	Internal code	IAH0	

Precaution for Use

(1) Storage

To avoid the moisture penetration, we recommend store in a dry box with a desiccant.

The maximum storage temperature range is 40°C and a maximum humidity of RH90%.

(2) Use Precaution after Opening the Packaging

Use proper SMT techniques when the LED is to be soldered dipped as separation of the lens may affect the light output efficiency.

Pay attention to the following:

a. Recommend conditions after opening the package

- Sealing

- Temperature : 30°C Humidity : less than RH60%

b. If the package has been opened more than 4 week(MSL_2a) or the color of the desiccant changes, components should be dried for 10-24hr at 65±5°C

(3) Do not apply mechanical force or excess vibration during the cooling process to normal temperature after soldering.

(4) Do not rapidly cool device after soldering.

(5) Components should not be mounted on warped (non coplanar) portion of PCB.

(6) Radioactive exposure is not considered for the products listed here in.

(7) Gallium arsenide is used in some of the products listed in this publication.

These products are dangerous if they are burned or shredded in the process of disposal.

It is also dangerous to drink the liquid or inhale the gas generated by such products when chemically disposed of.

(8) This device should not be used in any type of fluid such as water, oil, organic solvent and etc.

When washing is required, IPA (Isopropyl Alcohol) should be used.

(9) When the LEDs are in operation the maximum current should be decided after measuring the package temperature.

Precaution for Use

- (10) The appearance and specifications of the product may be modified for improvement without notice.
- (11) Long time exposure of sunlight or occasional UV exposure will cause lens discoloration.
- (12) VOCs (Volatile organic compounds) emitted from materials used in the construction of fixtures can penetrate silicone encapsulants of LEDs and discolor when exposed to heat and photonic energy. The result can be a significant loss of light output from the fixture. Knowledge of the properties of the materials selected to be used in the construction of fixtures can help prevent these issues.
- (13) Attaching LEDs, do not use adhesives that outgas organic vapor.
- (14) The driving circuit must be designed to allow forward voltage only when it is ON or OFF.
If the reverse voltage is applied to LED, migration can be generated resulting in LED damage.
- (15) Similar to most Solid state devices;
LEDs are sensitive to Electro-Static Discharge (ESD) and Electrical Over Stress (EOS).
Below is a list of suggestions that Seoul Semiconductor purposes to minimize these effects.

a. ESD (Electro Static Discharge)

Electrostatic discharge (ESD) is defined as the release of static electricity when two objects come into contact. While most ESD events are considered harmless, it can be an expensive problem in many industrial environments during production and storage. The damage from ESD to LEDs may cause the product to demonstrate unusual characteristics such as:

- Increase in reverse leakage current lowered turn-on voltage
- Abnormal emissions from the LED at low current

The following recommendations are suggested to help minimize the potential for an ESD event. One or more recommended work area suggestions:

- Ionizing fan setup
- ESD table/shelf mat made of conductive materials
- ESD safe storage containers

One or more personnel suggestion options:

- Antistatic wrist-strap
- Antistatic material shoes
- Antistatic clothes

Environmental controls:

- Humidity control (ESD gets worse in a dry environment)

Precaution for Use

b. EOS (Electrical Over Stress)

Electrical Over-Stress (EOS) is defined as damage that may occur when an electronic device is subjected to a current or voltage that is beyond the maximum specification limits of the device. The effects from an EOS event can be noticed through product performance like:

- Changes to the performance of the LED package
(If the damage is around the bond pad area and since the package is completely encapsulated the package may turn on but flicker show severe performance degradation.)
- Changes to the light output of the luminaire from component failure
- Components on the board not operating at determined drive power

Failure of performance from entire fixture due to changes in circuit voltage and current across total circuit causing trickle down failures. It is impossible to predict the failure mode of every LED exposed to electrical overstress as the failure modes have been investigated to vary, but there are some common signs that will indicate an EOS event has occurred:

- Damaged may be noticed to the bond wires (appearing similar to a blown fuse)
- Damage to the bond pads located on the emission surface of the LED package
(shadowing can be noticed around the bond pads while viewing through a microscope)
- Anomalies noticed in the encapsulation and phosphor around the bond wires.
- This damage usually appears due to the thermal stress produced during the EOS event.

c. To help minimize the damage from an EOS event Seoul Semiconductor recommends utilizing:

- A surge protection circuit
- An appropriately rated over voltage protection device
- A current limiting device



Company Information

Published by

Seoul Semiconductor © 2013 All Rights Reserved.

Company Information

Seoul Semiconductor (www.SeoulSemicon.com) manufactures and packages a wide selection of light emitting diodes (LEDs) for the automotive, general illumination/lighting, Home appliance, signage and back lighting markets. The company is the world's fifth largest LED supplier, holding more than 10,000 patents globally, while offering a wide range of LED technology and production capacity in areas such as "nPola", "Acrich", the world's first commercially produced AC LED, and "Acrich MJT - Multi-Junction Technology" a proprietary family of high-voltage LEDs.

The company's broad product portfolio includes a wide array of package and device choices such as Acrich and Acirch2, high-brightness LEDs, mid-power LEDs, side-view LEDs, and through-hole type LEDs as well as custom modules, displays, and sensors.

Legal Disclaimer

Information in this document is provided in connection with Seoul Semiconductor products. With respect to any examples or hints given herein, any typical values stated herein and/or any information regarding the application of the device, Seoul Semiconductor hereby disclaims any and all warranties and liabilities of any kind, including without limitation, warranties of non-infringement of intellectual property rights of any third party. The appearance and specifications of the product can be changed to improve the quality and/or performance without notice.